

# TECHDOT

[www.loxone.com](http://www.loxone.com)

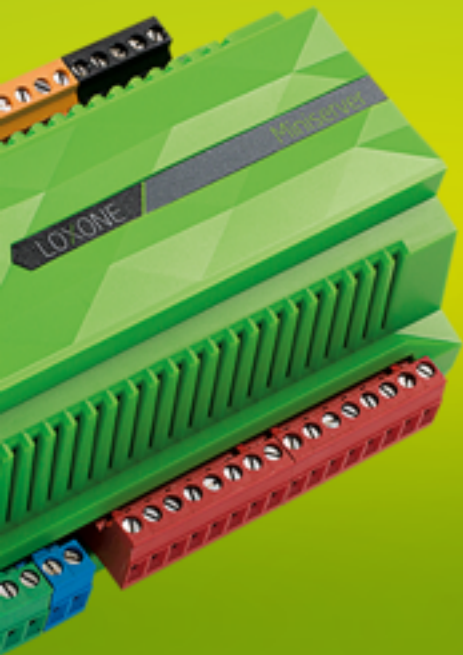

## LOXONE

### System chytrého domu

LOXONE

The Miniserver based  
Smart Home.



[www.facebook.com/LoxoneCZ](http://www.facebook.com/LoxoneCZ)



[gplus.to/LoxoneCZ](http://gplus.to/LoxoneCZ)



[www.youtube.com/user/LoxoneVideoCZ](http://www.youtube.com/user/LoxoneVideoCZ)

# Conventional



# Bus based



# Miniserver-based

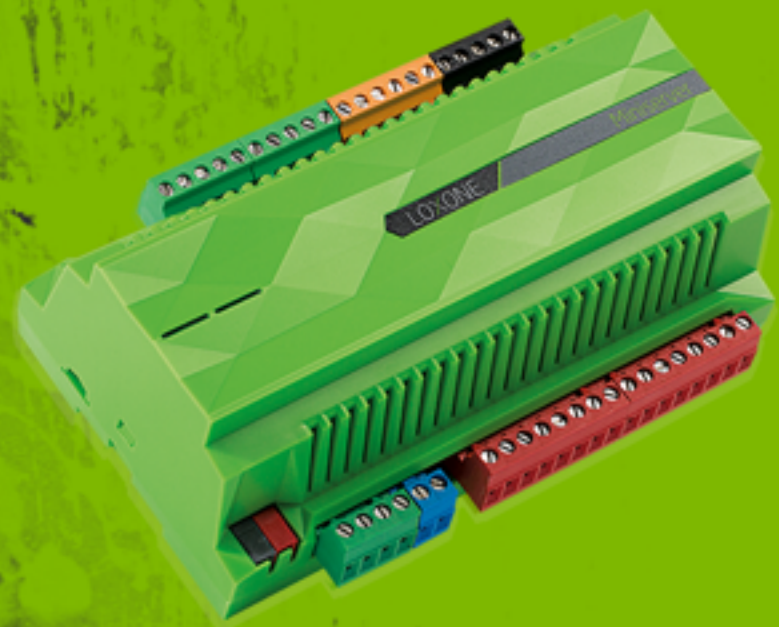

# Loxone Electronics

2009

Založeno: Thomas Moser  
Jednatelé: Martin Öller





# Loxone Basecamp

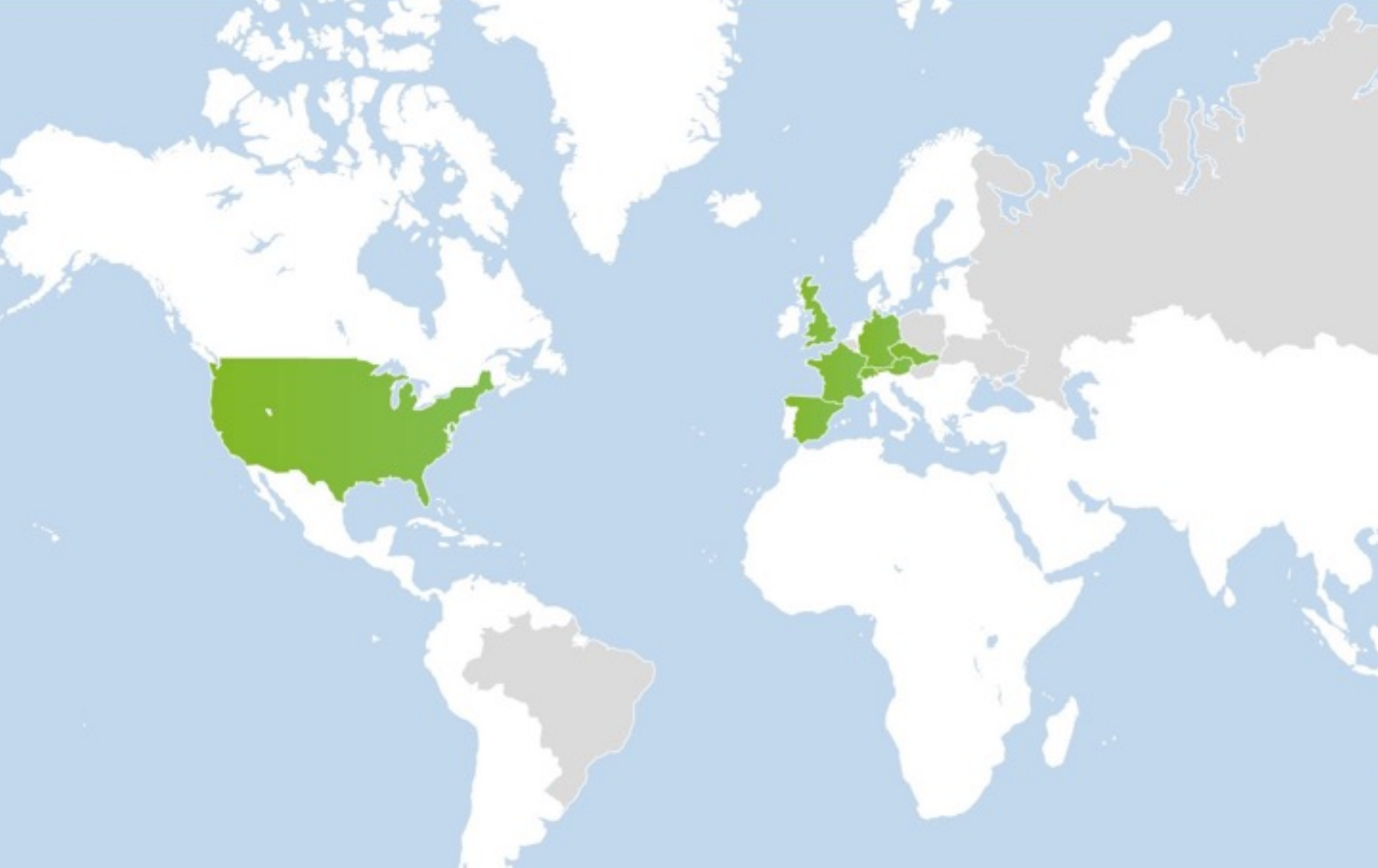

Loxone International

## Fakta & údaje LOXONE

Zaměstnanci v AT: 90

Zaměstnanci svět: 140

Loxone partneři: 7.500 partnerů na světě  
(elektrikáři, stavební firmy, architekti, ...)

Loxone pobočky: 8 - UK, CZ, ES, FR, US, AT, CH, IT

## Fakta & údaje TECHDOT.cz

**TECHDOT**

# Přehled řešení od Loxone



# Miniserver GO vs. Miniserver

Doporučené použití	Modernizace / renovace	Nová stavba
Loxone sběrnice & LAN	✓	✓
AIR technologie	✓	s AIR Base Extensionem
Digitální výstupy / vstupy	•	✓
Analogové výstupy / vstupy	•	✓
KNX	•	✓
Napájení	5VDC přes Micro USB	24V zdroj
Zdarma: Software, aktualizace, podpora	✓	✓
Loxone OS	✓	✓
Loxone App	✓	✓
Cena	6499 Kč bez DPH	10330 Kč bez DPH



# Dostupné Loxone Extensions



# Loxone Air produkty

# 6LoWPAN

Smoke  
Detector  
Air



Multi  
Extension  
Air



Smart  
Socket  
Air



RGBW  
Dimmer  
Air



Air Base



Miniserver  
Go



# Loxone Air produkty



# Loxone Air produkty

Hlavice  
Air



Senzor  
teploty a  
vlhkosti



Air Base



Miniserver  
Go



# Co je to chytrý dům?



- JEDNODUCHÉ OVLÁDÁNÍ
- INTELIGENTNÍ AUTOMATIZACE
- NAVRŽENO PRO KAŽDOU DOMÁCNOST

# Intelligentní automatizace - Miniserver



# Když chytrý dům, tak kabeláž do hvězdy!

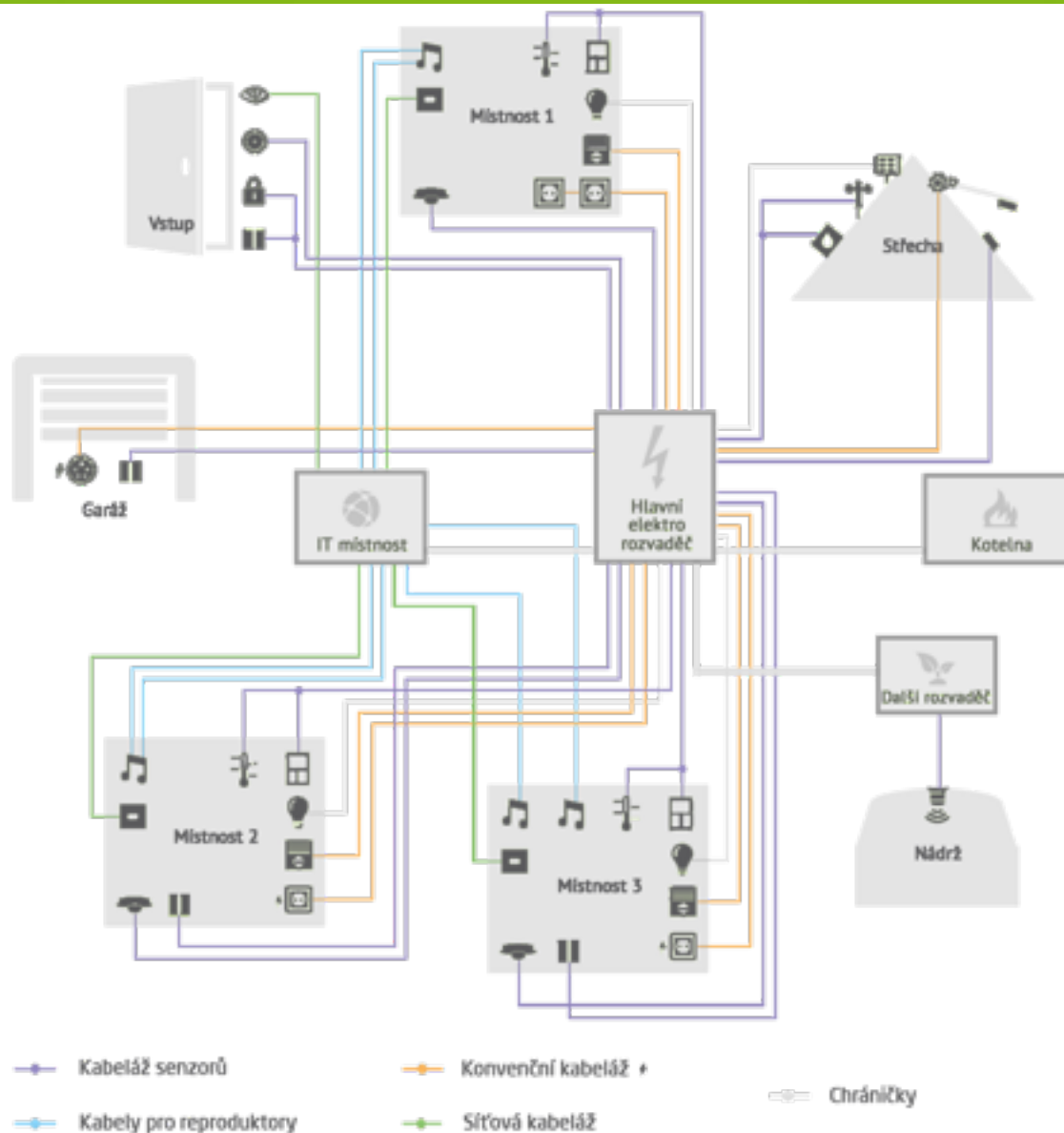

# Kabeláž v chytrém domě - budoucnost

## CAT 7

- Izolační odpor 500 V  $\geq 2000 \text{ M}\Omega \cdot \text{km}$
- Popisky po metru
- Délka: 250 m
- IEEE 802.3: 10Base-T; 100Base-T; 1000Base-T; 10GBase-T
- IEEE 802.5: 16 MB; ISDN; TPDDI; ATM
- S/FTP
- PiMF
- 4x2xAWG23
- 1000Mhz

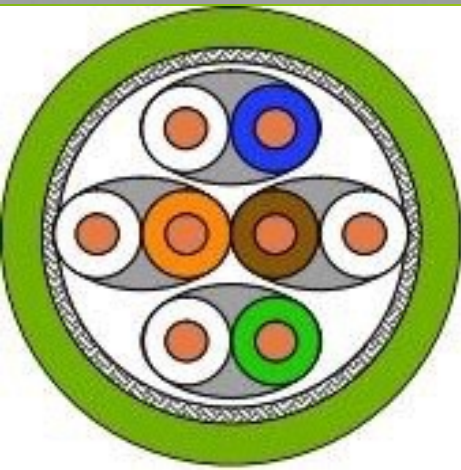
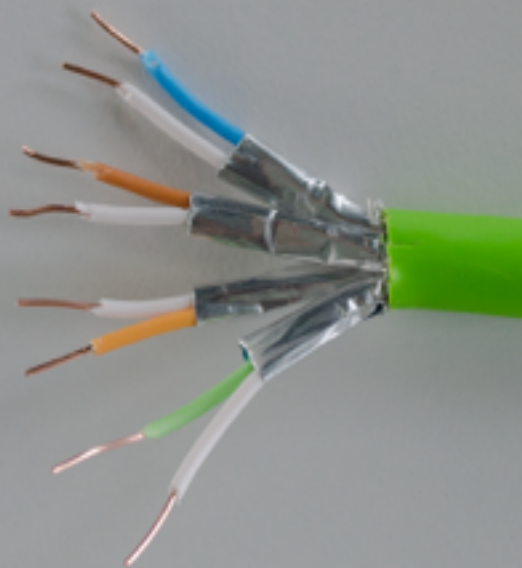



# Rozvaděč v každém patře

Podkroví



Přízemí



Podsklepení



# Loxone Standard - 5ti tlačítko

ZAPNOUT SVĚTLA /  
VÝBĚR SCÉNY ●



●● V POKOJI VŠE VYPNOUT

●●● V DOMĚ VŠE VYPNOUT

6 "žilek"

NAHORU ●

DOLŮ ●

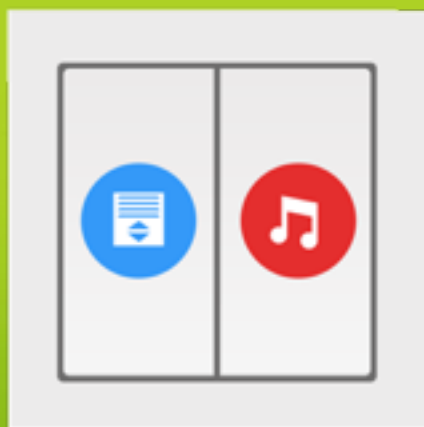

● ZAPNOUT / HLASITĚJI  
●● VÝBĚR ZDROJE

● ZESLABIT  
●● VYPNOUT

+2 vodiče



1-Wire

## Automatizace

- Stínění
- Osvětlení
- Vytápění
- Úspora energie
- Audio
- Přístupový systém
- Alarm
- Centrální funkce
- Sauna
- atd.

vs.

## Provoz

- Dvojklik: Vypnutí místnosti - světla, audio,...
- Trojklik: Vypnutí domu / centrální vypnutí
- Vzdálený přístup přes telefon odkudkoliv



# PROJEKCE - nejen chytré krabičky

Dostatečný počet zásuvek  
Správně umístěné vypínače  
Přístupový systém  
Zálohování  
Wi-Fi a GSM  
Návrh svítidel  
Audio - video  
Exteriéry  
Závlaha  
Technologie - HVAC  
EZS - EPS



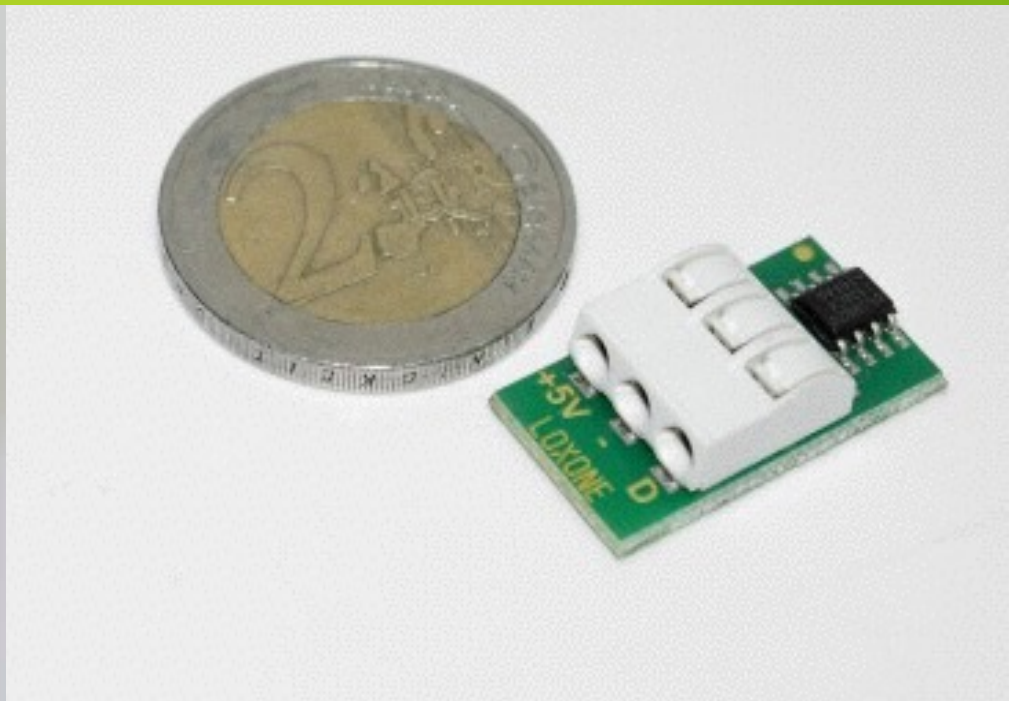







**SOUNDS BETTER!**

Sounds like **Loxone Speaker!**





# Řízení spotřeb Fotovoltaika







## Technická data

- › 100MBit síť + 2portový switch
- › Napájení po jednom kabelu
- › Úložiště pro obrázky a zvuky
- › Rychlý procesor
- › 2" barevný displej
- › 4 tlačítka se 4 RGB LEDs
- › Mikrofón
- › Reprodaktor
- › Infračervený senzor
- › Senzor přiblížení
- › Senzor okolního osvětlení
- › Denníhoční senzor

### Přídavné volitelné senzory

- › (přímo spojitelné s u::Lux Switch)
- › Senzor teploty
- › Senzor teploty a vlhkosti
- › Senzor pohybu, teploty a vlhkosti
- › Senzor CO2- & teploty & vlhkosti

Další technické informace naleznete v sekci „Ke stažení“

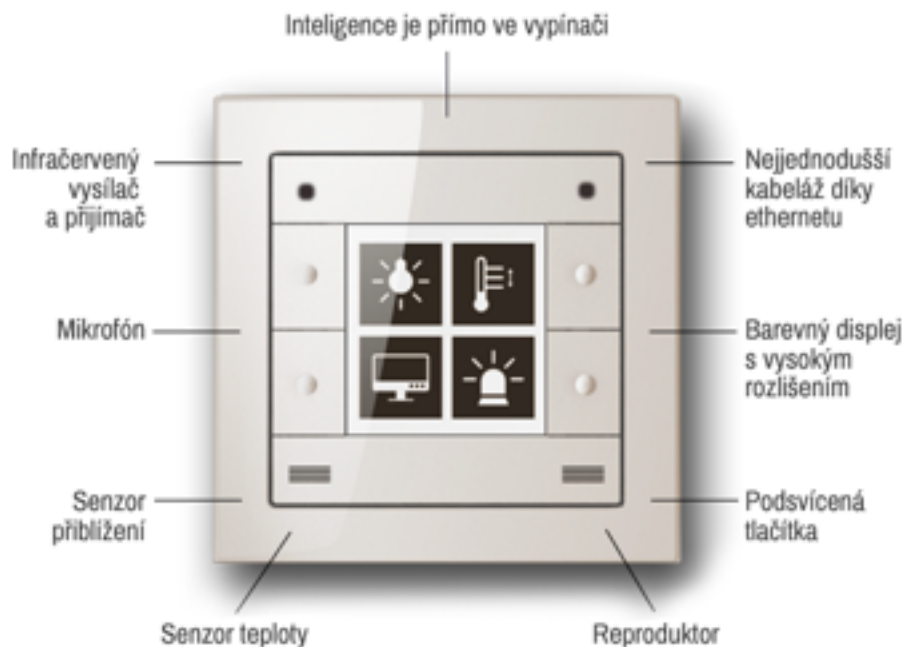







# NEJLEPŠÍ SOFTWARE PRO CHYTRÝ DŮM

Konfigurační software je zdarma a slouží pro nastavení Vašeho chytrého domu od Loxone. Zde můžete spustit uzdu své fantazie, protože s naším softwarem neexistuje žádné omezení. Nový Loxone Config je zde! Přesvědčte se sami!

Bezplatný konfigurační software Loxone Config - Loxone



## JEDNODUCHÉ POUŽITÍ

Programování inteligentních domů nebylo nikdy tak jednoduché jako s našim konfiguračním softwarem. Přesvědčte se sami a získajte úplně vše, co potřebujete.



## ZDARMA

Software pro inteligentní domy je zcela zdarma ke stažení. Přesvědčte se sami a poznejte mnohem více o výhodách bezplatného konfiguračního softwaru.



Dokumentation: Loxone Config  
Simulationsmodus - Loxone

## REŽIM SIMULACE

S režimem simulace si můžete předem vyzkoušet reálné fungování aplikace a najít případnou chybu. Mimo to si můžete software výborně otestovat i bez Miniserveru.

# LOXONE

The Miniserver based  
Smart Home.



## Part 1: Finding Your Way

[www.loxone.com](http://www.loxone.com)



# Děkuji

